

# **LB** Submersible Portable Dewatering Pump

- **LB-250/480** ● **LBT-250/480**
- **LB-250A/480A** ● **LBZ-480**
- **LB-800** ● **LBT-800**
- **LB-800A** ● **LBZ-800**

## **OPERATION MANUAL**

### **INTRODUCTION**

Thank you for selecting the Tsurumi LB Submersible General Dewatering Portable Pump for your application.

This equipment should not be used for applications other than those listed in this manual. Failure to observe this precaution may lead to a malfunction or an accident. In the event of a malfunction or an accident, the manufacturer will not assume any liability. After reading this Operation Manual, keep it in a location that is easily accessible, so that it can be referred to whenever information is needed while operating the equipment.

### **CONTENTS**

1. BE SURE TO READ FOR SAFTY.....	1
2. PART NAMES.....	4
3. PRIOR TO OPERATION .....	4
4. INSTALLATION .....	5
5. ELECTRICAL WIRING .....	8
6. OPERATION.....	10
7. MAINTENANCE AND INSPECTION.....	14
8. DISASSEMBLY AND REASSEMBLY PROCEDURE .....	16
9. TROUBLESHOOTING .....	18



# 1 BE SURE TO READ FOR YOUR SAFETY

Be sure to thoroughly read and understand the SAFETY PRECAUTIONS given in this section before using the equipment in order to operate the equipment correctly.



The precautionary measures described in this section are intended to prevent danger or damage to you or to others. The contents of this manual that could possibly be performed improperly are classified into two categories: **⚠ WARNING**, and **⚠ CAUTION**. The categories indicate the extent of possible damage or the urgency of the precaution. Note however, that what is included under **⚠ CAUTION** may at times lead to a more serious problem. In either case, the categories pertain to safety-related items, and as such, must be observed carefully.

- **⚠ WARNING** : Operating the equipment improperly by failing to observe this precaution may possibly lead to death or injury to humans.
- **⚠ CAUTION** : Operating the equipment improperly by failing to observe this precaution may possibly cause injury to humans and other physical damage.
- **NOTE** : Gives information that does not fall in the WARNING or CAUTION categories.

## ● Explanation of Symbols:









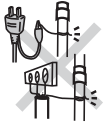

-  : The  $\triangle$  mark indicates a WARNING or CAUTION item. The symbol inside the mark describes the precaution in more detail ("electrical shock", in the case of the example on the left).
-  : The  $\circ$  mark indicates a prohibited action. The symbol inside the mark, or a notation in the vicinity of the mark describes the precaution in more detail ("disassembly prohibited", in the case of the example on the left).
-  : The  $\bullet$  mark indicates an action that must be taken, or instructs how to perform a task. The symbol inside the mark describes the precaution in more detail ("provide ground work", in the case of the example on the left).

## PRECAUTIONS TO THE PRODUCT SPECIFICATIONS

















<b>⚠ CAUTION</b>	
	<ul style="list-style-type: none"> <li>● Do not operate the product under any conditions other than those for which it is specified. <b>Failure to observe the precaution can lead to electrical leakage, electrical shock, fire, water overflow or other problems.</b></li> </ul>
	





## PRECAUTIONS DURING TRANSPORT AND INSTALLTION

<b>⚠ WARNING</b>	
<ul style="list-style-type: none"> <li>● When transporting the product, pay close attention to its center of gravity and mass. Use an appropriate lifting equipment to lift the unit. <b>Improper lifting may result in the fall of the product which could cause damage of the product or human injury.</b></li> </ul>	<ul style="list-style-type: none"> <li>● Install the product properly in accordance with this instruction manual. <b>Improper installation may result in electrical leakage, electrical shock, fire, water leakage, or injury.</b></li> </ul>
<ul style="list-style-type: none"> <li>● Electrical wiring should be performed in accordance with all applicable regulations in your country. <b>Imperfect wiring or neglecting the installation of proper equipment will cause electrical leakage or fire.</b></li> </ul>	<ul style="list-style-type: none"> <li>● Provide a secure grounding dedicated for the product. Never fail to provide an earth leakage circuit breaker and a thermal overload relay in your starter or control panel (Both available on the market). <b>If an electrical leakage occurs by due to a product failure, it may cause electrical shock.</b></li> </ul>
<ul style="list-style-type: none"> <li>● Use a power outlet that has a sufficient rating and has been exclusively provided for the pump. <b>If the power outlet is shared with other equipment, it can lead to an abnormal heat of the outlet and can cause fire as a result.</b></li> </ul>	<div style="text-align: right;">  </div>







⚠ CAUTION			
	<ul style="list-style-type: none"> <li>● Be sure to provide a ground wire securely. Do not connect the ground wire to a gas pipe, water pipe, lightning rod, or telephone ground wire. <b>Improper grounding could cause electrical shock.</b></li> </ul> 		<ul style="list-style-type: none"> <li>● Prevent a metallic object or dust from sticking to the power plug. <b>Adhesion of foreign object to the plug could cause electrical shock, short-circuit, or fire.</b></li> </ul> 
	<ul style="list-style-type: none"> <li>● Do not scratch, fold, twist, make alterations, or bundle the cable, or use it as a lifting device. <b>The cable may be damaged, which may cause electrical leakage, short-circuit, electrical shock, or fire.</b></li> </ul> 		<ul style="list-style-type: none"> <li>● Do not use the cable, power plug, or power outlet if it is damaged or it is not closely fitted. Connect every conductor of the cable securely to the terminals. <b>Failure to observe this can lead to electrical shock, short-circuit, or fire.</b></li> </ul> 
	<ul style="list-style-type: none"> <li>● This pump is neither dust-proof nor explosion-proof. Do not use it at a dusty place or at a place where toxic, corrosive or explosive gas is present. <b>Use in such places could cause fire or explosion.</b></li> </ul> 		<ul style="list-style-type: none"> <li>● When the product will be carried by hand, decide the number of persons considering the mass of the product. <b>When lifting up the product, do not attempt to do it by simply bowing from the waist. Use the knees, too, to protect your back.</b></li> </ul> 

## PRECAUTIONS DURING TEST OPERATION AND OPERATION

⚠ WARNING			
	<ul style="list-style-type: none"> <li>● Never try to operate the pump if somebody is present in the pump sump. <b>If an electrical leakage occurs, it can cause electrical shock.</b></li> </ul> 		<ul style="list-style-type: none"> <li>● Never start the pump while it is suspended, as <b>the unit may jerk and could lead to injury.</b></li> </ul> 
	<ul style="list-style-type: none"> <li>● When changing power connection is needed to correct the direction of rotation, be sure to turn off the power supply (earth leakage circuit breaker, etc.), and perform the work after making sure that the impeller has stopped completely. <b>Failure to do so may lead to electrical shock, short-circuit, or injury.</b></li> </ul> 		<ul style="list-style-type: none"> <li>● When inspecting the pump, be sure to turn off the power supply (earth leakage circuit breaker, etc.) so that the pump may not start accidentally. <b>Failure to do so may lead to a serious accident.</b></li> </ul> 
⚠ CAUTION			
	<ul style="list-style-type: none"> <li>● Do not operate the product under any voltage other than described on the nameplate with the voltage variation limit within <math>\pm 10\%</math>. If it is operated with a generator, it is strongly suggested not to operate other equipment with the same generator. <b>Failure to observe this caution may cause malfunction and breakdown of the product, which may lead to electrical leakage or electrical shock.</b></li> </ul> 		<ul style="list-style-type: none"> <li>● Do not touch the product with bare hands during or immediate after the operation, as the product may become very hot during operation. <b>Failure to observe this caution may lead to be burned.</b></li> </ul> 
	<ul style="list-style-type: none"> <li>● Do not use the product in a liquid other than water. <b>Use in oil, salt water or organic solvents will damage it, which may lead to electrical leakage or electrical shock.</b></li> </ul> 		<ul style="list-style-type: none"> <li>● Do not run the product dry or operate it with its gate valve closed, as <b>doing so will damage the product, which may lead to electrical leakage or electrical shock.</b></li> </ul> 

⚠ CAUTION			
⊘	<ul style="list-style-type: none"> <li>Do not use the product for hot or warm liquid over 40°C, as <b>doing so will damage the product, which may lead to electrical leakage or electrical shock.</b></li> </ul> 	⚡	<ul style="list-style-type: none"> <li>When the product will not be used for an extended period, be sure to turn off the power supply (earth leakage circuit breaker, etc.). <b>Deterioration of the insulation may lead to electrical leakage, electrical shock, or fire.</b></li> </ul>  
⊘	<ul style="list-style-type: none"> <li>Do not allow foreign object (pin, wire, etc.) to enter the suction inlet of the pump. <b>Failure to observe this caution could cause it to malfunction or to operate abnormally, which may lead to electrical leakage or electrical shock.</b></li> </ul> 		

## PRECAUTIONS DURING MAINTENANCE AND INSPECTION

⚠ WARNING			
⊘	<ul style="list-style-type: none"> <li>Absolutely turn off the power supply or disconnect the plug before starting maintenance or inspection. Do not work with wet hands. <b>Failure to observe these cautions may lead to electrical shock or injury.</b></li> </ul>   	⚡	<ul style="list-style-type: none"> <li>Do not disassemble or repair any parts other than those designated in the operation manual. If repairs are necessary in any other than the designated parts, consult with the dealer where it was purchased or Tsurumi representative. <b>Improper repairs can result in electrical leakage, electrical shock, fire, or water leakage.</b></li> </ul> 
!	<ul style="list-style-type: none"> <li>In case any abnormality (excessive vibration, unusual noise or odor) is found in the operation, turn the power off immediately and consult with the dealer where it was purchased or Tsurumi representative. <b>Continuing to operate the product under abnormal conditions may result in electrical shock, fire, or water leakage.</b></li> </ul>  		
⚠ CAUTION			
!	<ul style="list-style-type: none"> <li>After reassembly, always perform a test operation before resuming use of the product. <b>Improper assembly can result in electrical leakage, electrical shock, fire, or water leakage.</b></li> </ul>	 Test operation	

## PRECAUTION TO POWER OUTAGE

⚠ WARNING		
!	<ul style="list-style-type: none"> <li>In case of power outage, turn off the power supply. <b>The product will resume operation when the power is restored, which presents serious danger to people in the vicinity.</b></li> </ul>	 power outage OFF

## OTHER PRECAUTION

⚠ CAUTION		
⊘	<ul style="list-style-type: none"> <li>Never use the product for potable water. <b>It may present a danger to human health.</b></li> </ul>	 Potable Water

## 2 PART NAMES

### ■ Example

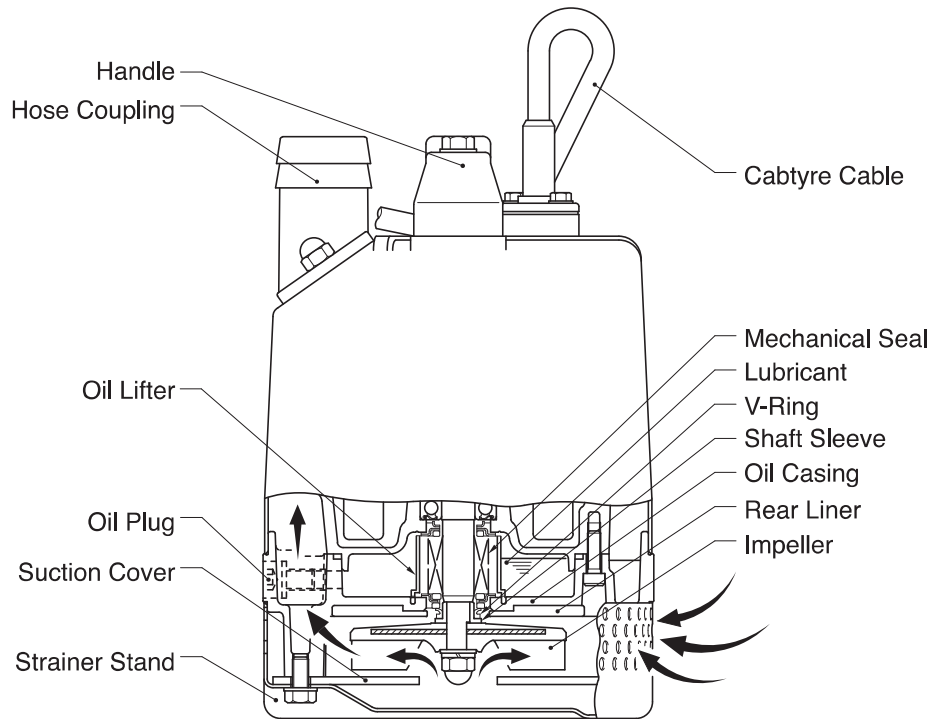

## 3 PRIOR TO OPERATION

After unpacking, verify the contents.

### ▶ Product Inspection

Inspect the product for damage during shipment, and make sure all bolts and nuts are tightened properly.

### ▶ Specification Check

Check the nameplate of the unit to verify that it is the product that you have ordered. Pay particular attention to its voltage and frequency specifications.

**Note:** *If you discover any damage or discrepancy in the product, please contact the dealer where this equipment was purchased or the Tsurumi sales office in your area.*

### ▶ Accessory Check

Verify that all accessory items are included in the package.

- Hose Band ..... 1 pc
- Operation Manual ..... 1

**Note:** *If you discover any damage or discrepancy in the product, please contact the dealer where this equipment was purchased or the Tsurumi sales office in your area.*

## Product Specifications

**CAUTION** Do not operate this product under any conditions other than those that have been specified.

### Major Standard Specifications

Applicable Liquids	Consistency and Temperature	Water, Rain Water, Font Water, Sand carrying Water, Ground Water ; 0 ~ 40°C
Pump	Impeller	Semi-Vortex-Type
	Shaft Seal	Double Mechanical Seal
	Bearing	Shielded Ball Bearing
Motor	Specifications	Dry Submersible Induction Motor, 2-Pole
	Insulation	Class E
	Protection System (built-in)	Miniature protector [LB-250(A),LB-480(A)(Z)] Circle thermal protector (other models)
	Lubricant	Turbine oil VG32 (non-additive)
Connection		Hose Coupling

### Standard specifications (50/60Hz)

Model	Bore mm	Phase	Starting Method	Output kW	Max.Head m ft.	Max.capacity m <sup>3</sup> /min GPM	WHT kg
LB-250	40	1	Capacitor-Run	0.25	8.8/8.6 28.9/28.2	0.190 50.2	10.4
LBT-250	40	3	Direct-on-line	0.25	8.8/8.6 28.9/28.2	0.190 50.2	10.0
LB-480	50	1	Capacitor-Run	0.48	11.0/12.0 36.1/39.5	0.220/0.240 58.1/63.4	10.4
LBT-480	50	3	Direct-on-line	0.48	11.0/12.0 36.1/39.5	0.220/0.240 58.1/63.4	10.0
LB-250A	40	1	Capacitor-Run	0.25	8.8/8.6 28.9/28.2	0.190 50.2	11.0
LB-480A	50	1	Capacitor-Run	0.48	11.0/12.0 36.1/39.5	0.220/0.240 58.1/63.4	11.0
LBZ-480	50	1	Capacitor-Run	0.48	11.0/12.0 36.1/39.5	0.220/0.240 58.1/63.4	10.4
LB-800	50	1	Capacitor-Run	0.75	15.0/18.0 49.0/59.0	0.31 82.0	13.2
LBT-800	50	3	Direct-on-line	0.75	15.0/18.0 49.0/59.0	0.31 82.0	12.8
LB-800A	50	1	Capacitor-Run	0.75	15.0/18.0 49.0/59.0	0.31 82.0	13.8
LBZ-800	50	1	Capacitor-Run	0.75	15.0/18.0 49.0/59.0	0.31 82.0	13.2

**Note:** The weight (mass) given above is the operating weight of the pump itself, not including the cable.

## 4 INSTALLATION

**CAUTION**

- The supply voltage should be within  $\pm 10\%$  of the rated voltage.
- The water temperature for operating the pump should be between 0 ~ 40°C. Failure to observe the precautions given above could cause the pump to malfunction, which may lead to current leakage or electrical shock.

**Note:** To use the pump for a special solution, contact the dealer where it was purchased, or the Tsurumi sales office in your area.

### Critical Use Pressure

**CAUTION** Do not operate the pump in an area that is exposed to a water pressure that exceeds the values given below.

Critical Use Pressure	0.2MPa (2kgf/cm <sup>2</sup> ) – discharge pressure during use
-----------------------	--

## Preparation for Installation

### Single-phase power supply:

Use a megger to measure the resistance between the tip of the cabtyre cable plug and the ground terminal to verify the insulation resistance of the motor.

Measure twice the resistance between each of the two tips of the plug and ground.

(This diagram shows a 2-pin plug type.)

Single-Phase

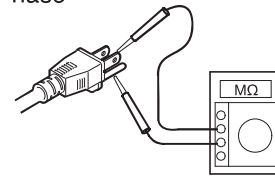

**CAUTION** Beware that the power plug varies by country or region.

### Three-phase power supply:

Use a megger to measure the resistance between each core of the cabtyre cable and the (green) ground wire to verify the insulation resistance of the motor.

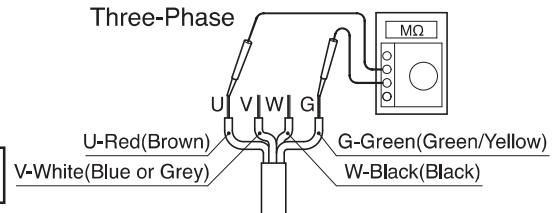

Insulation resistance reference value = 20MΩ minimum

**Note:** The insulation resistance reference value of 20MΩ minimum is based on a new or repaired pump. For reference values of a pump that has already been put into operation, refer to "7. Maintenance and Inspection" of this manual.

### How to use level relay unit (LB-250A/480A/800A ,LBZ-480/800)

#### CAUTION

- Do not measure the insulation resistance with insulation resistance tester for following parts. It causes a trouble.
- Do not lift or hang the level relay unit. It will damage and cause a leakage, an electric shock, and a fire.
- In the case of the float type, do not lift it by the float cable, as it will damage the cable, and lead to a leakage, electrical shock, and fire.

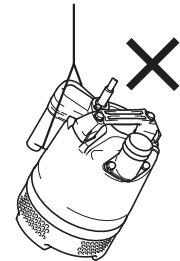

(1) between the plug

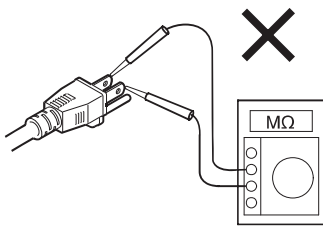

(2) between the electrode of a level relay unit

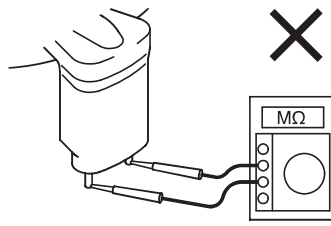

(3) between the electrode of a level relay unit and a plug

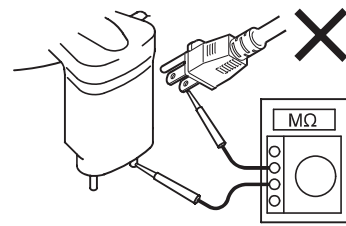

(4) Do not make "on" period between the other level relay unit.

## Precautions During Installation

#### WARNING

When installing the pump, be mindful of the pump's center of gravity and weight. If the pump is not suspended properly, the pump may fall and break, which may lead to injury.

#### CAUTION

When installing or moving the pump, never suspend the pump by the cabtyre cable. Doing so will damage the cable, which may cause a current leakage, electrical shock, or fire.

(1) When a hose is used, attach the hose to the hose coupling as far as it will go, then fasten it securely with a hose band.

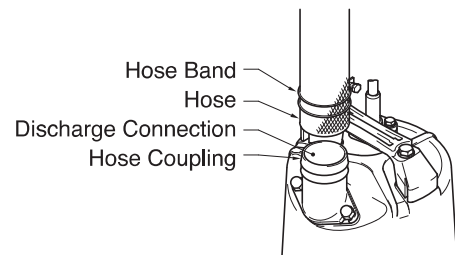

- (2) Handle the pump carefully without applying shock to it, such as by dropping it. To suspend the pump, do so manually or by attaching a rope or chain to its handles.

**CAUTION** The rope for suspending the pump during its installation must be of a thickness that accommodates the weight of the pump. When using a chain, make sure that the chain does not become twisted. Failure to observe these precautions could cause the rope or chain to break and the pump to fall and break, which could lead to personal injury.

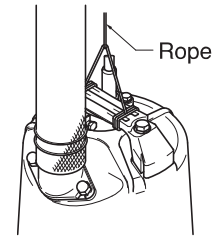

- (3) Operate the pump in a location that has a sufficient water level and collects water easily.

**Note:** For the water level required for operating the pump, refer to the external dimension drawing, which is provided separately. Extend the end of the hose (discharge side) above the water surface. If the end of the hose is submerged in water, it may cause the water to flow back when the pump has been stopped. Conversely, if the end of the hose is located at a level that is lower than the source water surface, water may continue to flow out even after the pump has been stopped.

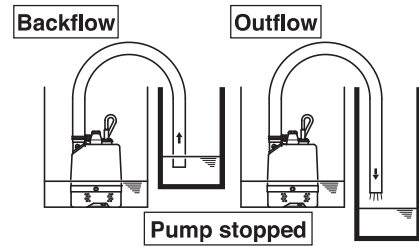

- (4) Route the hose as straight as possible. Excessive bending of the hose could obstruct the flow of water, reduce the pumping volume, or clog the pump with mud, thus disabling the pumping function. If the hose is kinked at its base, it will create air pockets in the pump, causing the pump to operate dry. To prevent this from occurring, straighten the bend while operating the pump.

If the hose becomes kinked as shown in (A), reposition the hose coupling so that it faces as shown in (B). Loosen the cap nut on the hose coupling to change its direction.

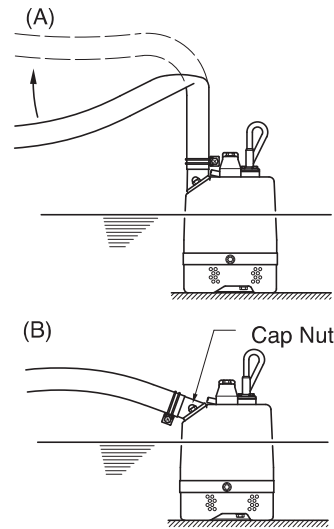

**CAUTION** If the pump draws in a large amount of mud, it could cause the pump to wear prematurely and lead to a malfunction, current leakage, and electrical shock.

- (5) Operate the pump upright. If there is the likelihood of the pump drawing in excess mud, place a concrete block under the pump.

### Installing the Float

Set the length of the float lead wire to the dimension indicated below. Failure to observe this will lead to an improper operation.

Pump model	L
LBZ-480	150mm
LBZ-800	200mm

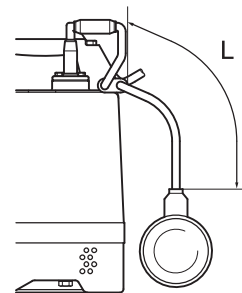



# 5 ELECTRICAL WIRING

## Electrical Wiring Work

- WARNING**
- All electrical work must be performed by an authorized electrician, in compliance with local electrical equipment standards and internal wiring codes. Never allow an unauthorized person to perform electrical work because it is not only against the law, but it can also be extremely dangerous.
  - Improper wiring can lead to current leakage, electrical shock, or fire.
  - Absolutely provide a dedicated earth leakage circuit breaker and a thermal overload relay suitable for the pump (available on the market). Failure to follow this warning can cause electrical shock or explosion when the product fails or an electrical leakage occurs.

Operate well within the capacity of the power supply and wiring.

### Grounding

- WARNING** Be sure to install the ground wire securely. Failure to observe this precaution could damage the pump and cause current leakage, which may lead to electrical shock.

- CAUTION** Do not connect the ground wire to a gas pipe, water pipe, lightning rod, or telephone ground wire. Improper grounding could cause electrical shock.

### Connecting the Power Plug

- WARNING** Before inserting the power plug or connecting the wires to the terminal board, make sure that the power supply (i.e. circuit breaker) is properly disconnected. Failure to do so may lead to electrical shock, short, or injury caused by the unintended starting of the pump.

- CAUTION** Do not use damaged cable cables, power plugs, or loose power outlets. Failure to observe this precaution could lead to electrical shock, short circuit, or fire.

Follow the diagram on the right to connect the power.

When using a three-prong grounded plug, connect as shown in the drawing.

- CAUTION** Be sure to use a dedicated power supply with a ground leakage circuit breaker.

(This diagram shows a 2-pin plug type.)

- CAUTION** Beware that the power plug varies by country or region.

**Note:** *The shape of the plug may differ from that shown in the illustration.*

When a single-phase power source is used, connect the leads to the control panel terminals as shown in the diagram, making sure they do not become twisted together.

When a three-phase power source is used, connect the leads to the control panel terminals as shown in the diagram, making sure they do not become twisted together.

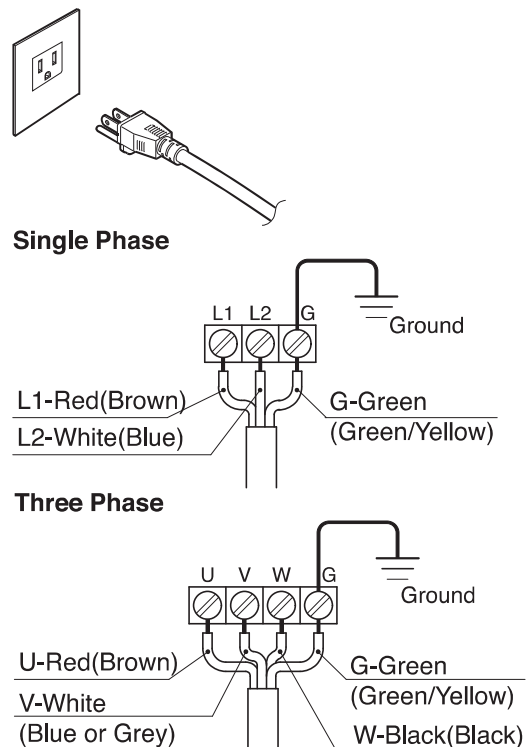

## Motor Protector

The pump is equipped with a built-in motor protector (circle thermal protector / miniature protector).  
If a current overload or overheating occurs under the symptoms given below, the pump will stop automatically to protect the motor regardless of the water level at the time of operation.

- Extreme fluctuation of power supply voltage
- Pump operated under overload condition
- Pump operated at open phase or binding condition

**Note:** After the motor protector has tripped, the motor automatically resumes its operation. Therefore, make sure to disconnect the cable from the terminal board or the power outlet, and eliminate the cause of the problem.

Do not operate the pump at unusually low head, or with the impeller clogged with debris. Doing so will not only prevent the pump from attaining its full potential, but may also generate abnormal noise and vibration and damage the pump.

## Electrical Circuit Diagrams

### Non-Automatic Circuit LB-250 , LB-480

Power Supply: Single-Phase

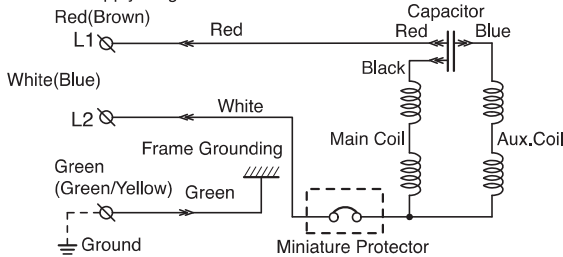

### Non-Automatic Circuit LB-800

Power Supply: Single-Phase

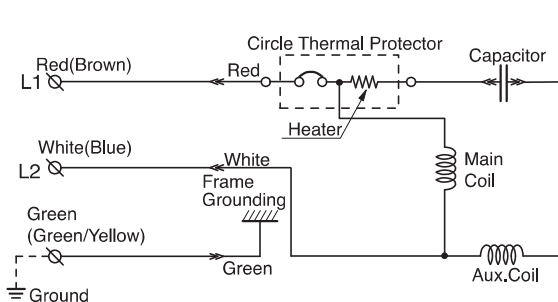

### Automatic Operation Circuit (for electrode type) LB-800A

Power Supply: Single-Phase

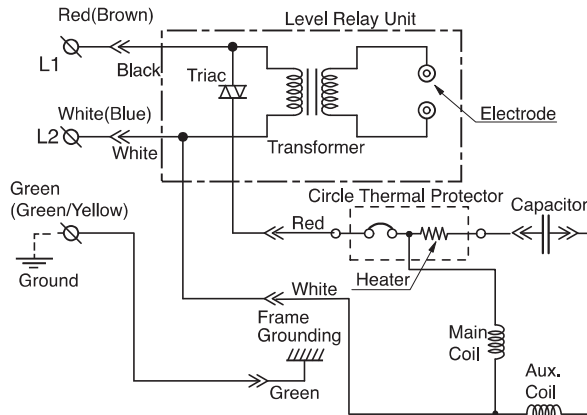

### Non-Automatic Circuit

LB-250 , LB-480 , LB-800

Power Supply: Three-Phase

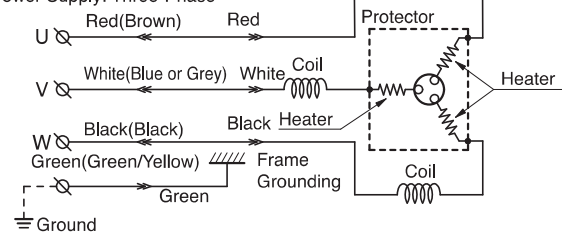

### Automatic Operation Circuit (Level Relay Unit)

LB-250A , LB-480A

Power Supply: Single-Phase

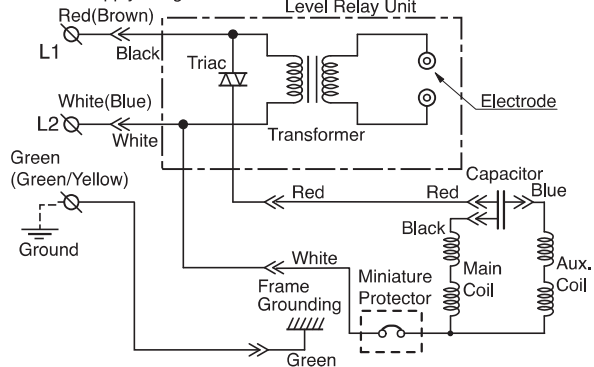

### Automatic Operation Circuit (for float type)

LBZ-480

Power Supply: Single-Phase

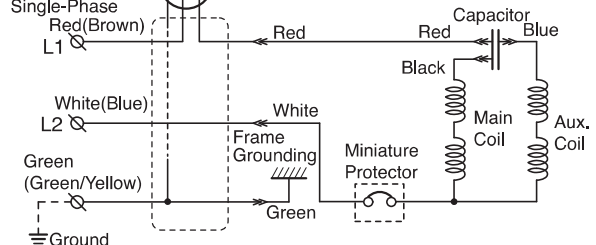

### Automatic Operation Circuit (for float type)

LBZ-800

Power Supply: Single-Phase

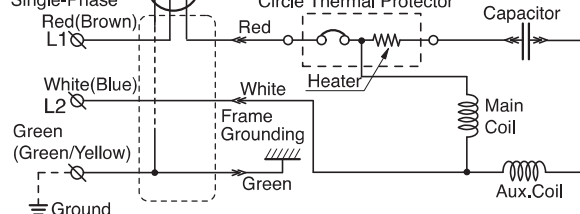

# 6 OPERATION

## Prior to Operation

- (1) Once again, check the nameplate of the pump to verify that its voltage and frequency are correct.

**CAUTION** Improper voltage and frequency of the power supply will prevent the pump from attaining its full potential, and may also damage the pump.

**Note:** Verify the specs on the pump's nameplate.

- (2) Check the wiring, power supply voltage, the capacity of the ground leakage circuit breaker, and the insulation resistance of the motor.

■ Insulation resistance reference value = 20MΩ minimum

**Note:** The insulation resistance reference value of 20MΩ minimum is based on a new or repaired pump. For reference values of a pump that has already been put into operation, refer to "Maintenance and Inspection".

- (3) Adjust the setting of the thermal relay (i.e. 3E relay) to the pump's rated current.

**Note:** Verify the rated current on the pump's nameplate.

- (4) When using a generator, as much as possible avoid operating the pump in conjunction with other types of equipment.

## 6-1 NON-AUTOMATIC OPERATION

### Trial Operation

**WARNING** Never start the pump while it is suspended, as the pump may jerk and cause a serious accident involving injury.

- (1) Operate the pump for a short time (1 to 2 seconds) and verify the direction of the rotation of the impeller. Observe the pump unit from above, and if its recoil is in the counterclockwise direction, the direction of its rotation is correct.

**CAUTION** Make sure to check the pump's direction of rotation with the pump exposed to the atmosphere. Operating the pump in reverse while it is submerged in water will damage the pump, which may lead to current leakage and electrical shock.

- (2) To reverse the rotation, the following countermeasures must be taken.

**WARNING** Before changing the connections for reverse rotation, make sure that the power supply (i.e. circuit breaker) is properly disconnected and that the impeller has stopped completely. Failure to observe this may lead to electrical shock, short, or injury.

#### COUNTERMEASURE

Interchange any two of the three wires designated U, V, and W, respectively.

**Note:** (1) and (2) are applied to the three-phase pumps.

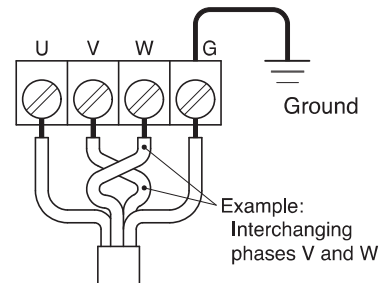

(3) Connect the pump to the pipe and submerge it in water.

(4) Operate the pump for a short time (3 to 10 minutes) and perform the following checks:

Using an AC ammeter (clamp), measure the operating current at the phases U, V, and W that are connected to the terminal board.

**COUNTERMEASURE**

Because an overload condition may be present at the pump motor if the operating current exceeds the rated current, follow the instructions in section "4. Installation" to operate the pump in the correct manner.

Using an AC voltmeter (tester), measure the voltage at the terminal board.

■ Power supply voltage variation = within  $\pm 10\%$  of the rated voltage

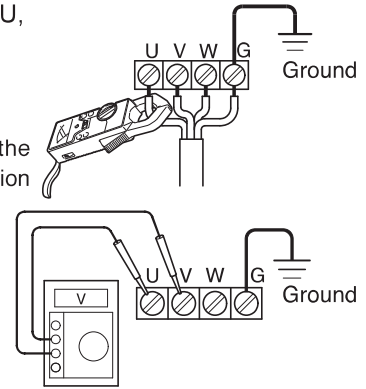

**COUNTERMEASURE**

If the power supply voltage deviates from the variation value, the cause of the deviation may be the capacity of the power supply or the extension cable that is used. Refer to section "5. Electrical Wiring" to operate the pump in the correct manner.

**CAUTION** In case the pump exhibits an abnormal condition (such as a considerable amount of vibration, noise, or smell), disconnect the power supply immediately and contact the dealer where you purchased the equipment, or Tsurumi's sales office in your area. If the pump continues to be used in the abnormal state, it may cause current leakage, electrical shock, or fire.

(5) Proceed with the normal operation if no abnormal conditions are found during the trial operation.

**Operation**

**WARNING** The pump unit may be extremely hot during operation. To prevent burns, do not touch the pump unit with bare hands during or after the operation.

Pay attention to the water level during the pump operation. The pump may become damaged if it is allowed to operate dry.

Due to an overload operation or a pump malfunction, if the motor protector trips to stop the pump, make sure to eliminate the cause of the problem before restarting.

To operate a submersible pump (including automatic operation), set the water level so that the pump will operate about 10 times per hour.

**Note:** A large amount of amperage flows when a submersible pump is started, causing the temperature of its windings to rise rapidly. Beware that a frequent stop-and-go operation of the pump will accelerate the deterioration of the insulation of the motor windings and thus affect the use life of the motor.

**Operating Water Level**

**CAUTION** Do not operate the pump below the C.W.L. (Continuous Running Water Level) indicated below. Failure to observe this condition may result in damage to the pump, electrical leakage or electrical shock.

Pump Model	C.W.L. (mm)
LB-250	50
LBT-250	50
LB-480	50
LBT-480	50
LB-800	50
LBT-800	50

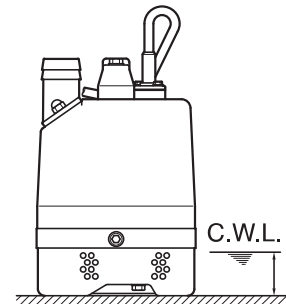

## 6-2 Automatic Operation (for float type)

### Trial Operation

Equipped with floats to detect the water level the automatic type (LBZ) pump can perform an automatic drainage operation alone by merely connecting its cable to a power supply.

Connect the power and perform a trial operation as follows:

- (1) Direct all the floats downward.
- (2) Raise the (yellow) float. This will cause the pump to start.
- (3) Next, return the (yellow) float to their original positions. This will cause the pump to stop.
- (4) Perform steps (2) and (3) consecutively two or more times to verify the operation.

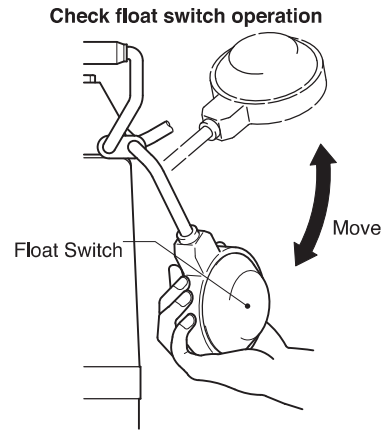

**Note:** *The trial operation must be completed within 1 minute.*

**CAUTION** In case the pump exhibits an abnormal condition (such as a considerable amount of vibration, noise, or smell), disconnect the power supply immediately and contact the dealer where you purchased the equipment, or Tsurumi's sales office in your area. If the pump continues to be used in the abnormal state, it may cause current leakage, electrical shock, or fire.

## 6-3 Automatic Operation (for electrode type)

### Operation Water Level

#### Start of the pump

The pump starts when the current continuously flows between the two electrodes for more than one (1) second.

**Note:** *The electrode may not detect the water surface under conditions such as purified water or distilled water which the current does not flow cause of high specific resistance.*

**Note:** *The necessary water level to operate the pump is 115mm or 170mm from the bottom of a pump. In case of start by racing during the trial operation, please short-circuit for more than one (1) second with exciting items (screw driver etc.) between the electrodes, and start forcibly. Please keep away from those that may clog in a pump. (wire, nail, cord, etc.)*

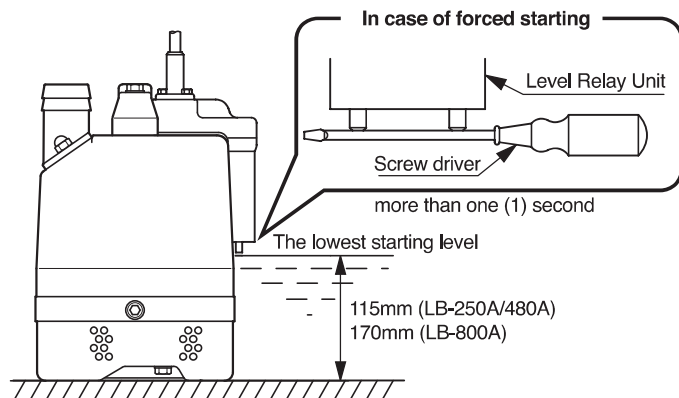

### Trial Operation

**WARNING** Never start the pump while it is suspended, as the pump may jerk and cause a serious accident involving injury.

- (1) Operate the pump 3 to 10 minutes to verify the conditions listed below.

**CAUTION** In case the pump exhibits an abnormal condition (such as a considerable amount of vibration, noise, or smell), disconnect the power supply immediately and contact the dealer where you purchased the equipment, or Tsurumi's sales office in your area. If the pump continues to be used in the abnormal state, it may cause current leakage, electrical shock, or fire.

- (2) Proceed with the normal operation if no abnormal conditions are found during the trial operation.

# Operation Flow Chart

To enable the user to bring the pumps ability into full play, this chart describes the various control modes that are made possible by the combinations of the electrode and timer functions.

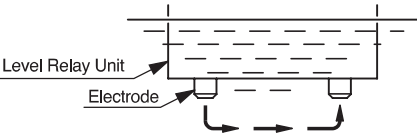
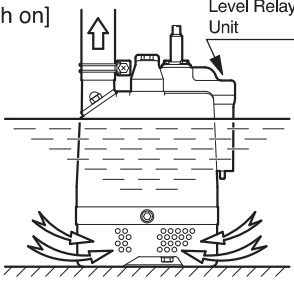
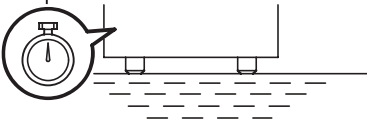
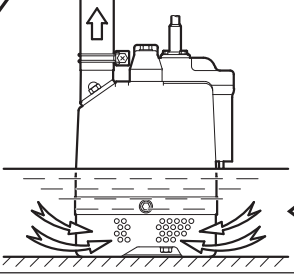
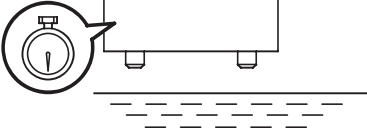
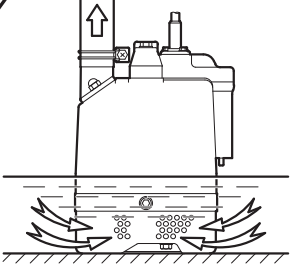
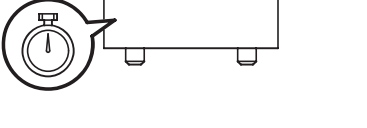
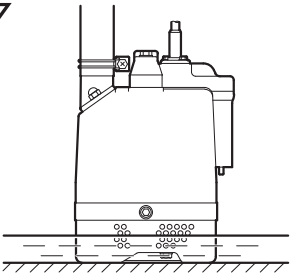
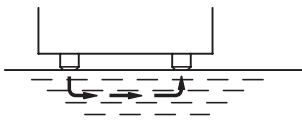
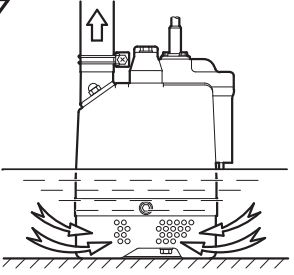
Level Relay Unit	Pump	Water Level	Condition
<p>The electrodes of the level relay unit are submerged, causing the current to operate the pump.</p>  <p>(Detection Time : more than one (1) second)</p>	Start Operation (Drainage)	Drop	<p>[Switch on]</p> 
<p>As the water level drops and the water surface recedes from the electrodes, the timer trips to drain water.</p>  <p>(Electrodes open Trips the timer)</p>	Operation (Drainage)	Drop	
<p>The draining of water by the timer lasts approximately 1 minute.</p> <p>* If the water surface comes in contact for more than one (1) second with the electrodes within 1 minute, the pump will operate continuously even though the timer has tripped.</p> 	Operation (Drainage)	Drop	
<p>The pump will stop 1 minute later.</p>  <p>* The pump will also stop after a continuous dry run, in some cases.</p>	Stop	Rise	
<p>When the water level rises and the water surface comes in contact for more than one (1) second with the electrodes, the pump will restart.</p>  <p>(Detection Time : more than one (1) second)</p>	Start Operation (Drainage)	Drop	

# 7 MAINTENANCE AND INSPECTION

Regular maintenance and inspection are indispensable to maintaining the pump's performance. If the pump behaves differently from its normal operating condition, refer to section "9. Troubleshooting" and take appropriate measures at an early stage. We also recommend that you have a spare pump on hand for an emergency.

## Prior to Inspection

**WARNING** Make sure that the power supply (i.e. circuit breaker) is disconnected and disconnect the cabtyre cable from the power outlet or remove it from the terminal board. Failure to do so may cause electrical shock or unintended starting of the pump, which may lead to serious accidents.

- (1) Washing the Pump  
Remove any debris attached to the pump's outer surface, and wash the pump with tap water. Pay particular attention to the impeller area, and completely remove any debris from the impeller.
- (2) Inspecting the Pump Exterior  
Verify that there is no damage, and that the bolts and nuts have not loosened.

**Note:** *If the pump must be disassembled for repair due to damage or loose bolts or nuts, contact the dealer where it was purchased, or the Tsurumi sales office in your area.*

## Daily and Periodic Inspection

Interval	Inspection Item
Daily	Measuring the operating current ■ To be within the rated current Measuring the power voltage ■ Power supply voltage variation = within $\pm 10\%$ of the rated voltage
Monthly	Measuring the insulation resistance ■ Insulation resistance reference value = 1M $\Omega$ minimum [NOTE] The motor must be inspected if the insulation resistance is considerably lower than the last inspection.
Semi-yearly	Inspecting oil ■ 1,000 hours or 6 months, whichever comes first. Inspection of lifting rope ■ Replace if damage, corrosion, or wear has occurred to the rope. Remove if foreign object is attaching to it.
Yearly	Changing oil ■ 2,000 hours or 12 months, whichever comes first. Changing the mechanical seal [NOTE] The inspection and replacement of the mechanical seal requires specialized equipment. To have this operation performed, contact the dealer where this equipment was purchased, or the Tsurumi sales office in your area.
Once every 2 to 5 years	Overhaul ■ The pump must be overhauled even if the pump appears normal during operation. Especially, the pump may need to be overhauled earlier if it is used continuously. [NOTE] To overhaul the pump, contact the dealer where it was purchased, or the Tsurumi sales office in your area.

**Note:** *Refer to section "Oil Inspection and Change Procedures" below for further detail.*

## Storage

If the pump will not be operated for a long period of time, pull the pump up, wash the pump, allow it to dry, and store it indoors.

**Note:** For reinstallation, be sure to perform a trial operation before putting the pump into operation.

If the pump remains immersed in water, operate it on a regular basis (i.e. once a week).

## Oil Inspection and Changing Procedures

### Inspecting Oil

Remove the oil plug and take out a small amount of oil. The oil can be extracted easily by tilting the pump so that the oil filler plug faces downward. If the oil appears milky or intermixed with water, a likely cause is a defective shaft sealing device (i.e. mechanical seal), which requires that the pump be disassembled and repaired.

### Changing Oil

Remove the oil plug and drain the oil completely. Pour a specified volume of oil into the oil filler inlet.

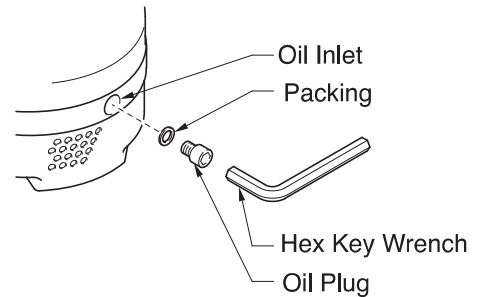

**Note:** The drained oil must be disposed of properly to prevent it from being released into the sewer or rivers. The packing or the O-ring for the oil plug must be replaced with a new part at each oil inspection and change.

Specified Oil: Turbine Oil VG32 (non-additive)

Unit : ml

Pump Model	Specified Volume
LB-250, LBT-250, LB-250A	155
LB-480, LBT-480, LB-480A, LBZ-480	155
LB-800, LBT-800, LB-800A, LBZ-800	155

## Replacement Parts

The table lists the parts that need to be replaced periodically. Replace these using the recommended frequency as a guideline.

Part	Replacement condition
Mechanical Seal	When oil in oil compartment becomes milky.
Lubricant ; Turbine Oil VG 32 (non-additive)	Every 12 mouths or after 2,000 hours of use, whichever comes first.
Packing, O-Ring	Each time pump is disassembled or inspected
V-Ring	When ring is worn, and each time pump is disassembled or inspected
Shaft sleeve	When it becomes worn



## 8 DISASSEMBLY AND REASSEMBLY PROCEDURE

Prior to Disassembly and Reassembly



### WARNING

Before disassembling and reassembling the pump, be sure that the power supply (i.e. circuit breaker) is disconnected, and remove the cabtyre cable from the outlet or the terminal board. Do not connect or disconnect the power plug with a wet hand, in order to prevent electrical shock. Do not perform an activation test (to check the rotation of the impeller) during disassembly and reassembly. Failure to observe this precaution could lead to a serious accident, including injury.

This section explains the disassembly and reassembly processes that are involved up to the replacement of the impeller itself. Operations involving the disassembly and reassembly of the sealing portion (i.e. mechanical seal) and of the motor require a specialized facility including vacuum and electrical test equipment. For these operations, contact the dealer where this equipment was purchased, or the Tsurumi sales office in your area.

### Disassembly Procedure

- (1) Removing the strainer stand, suction cover, and the pump casing  
Remove the hex bolts from under the strainer stand; then, remove the strainer stand, suction cover, and the pump casing from the pump body.
- (2) Removing the impeller  
Using a box wrench, remove the impeller nut, spring washer and plain washer, then, remove the impeller, the shaft sleeve, and the v-ring from the shaft.
- (3) Removing the rear liner  
Remove the rear liner from the oil casing.

### Disassembly Diagram

#### Example

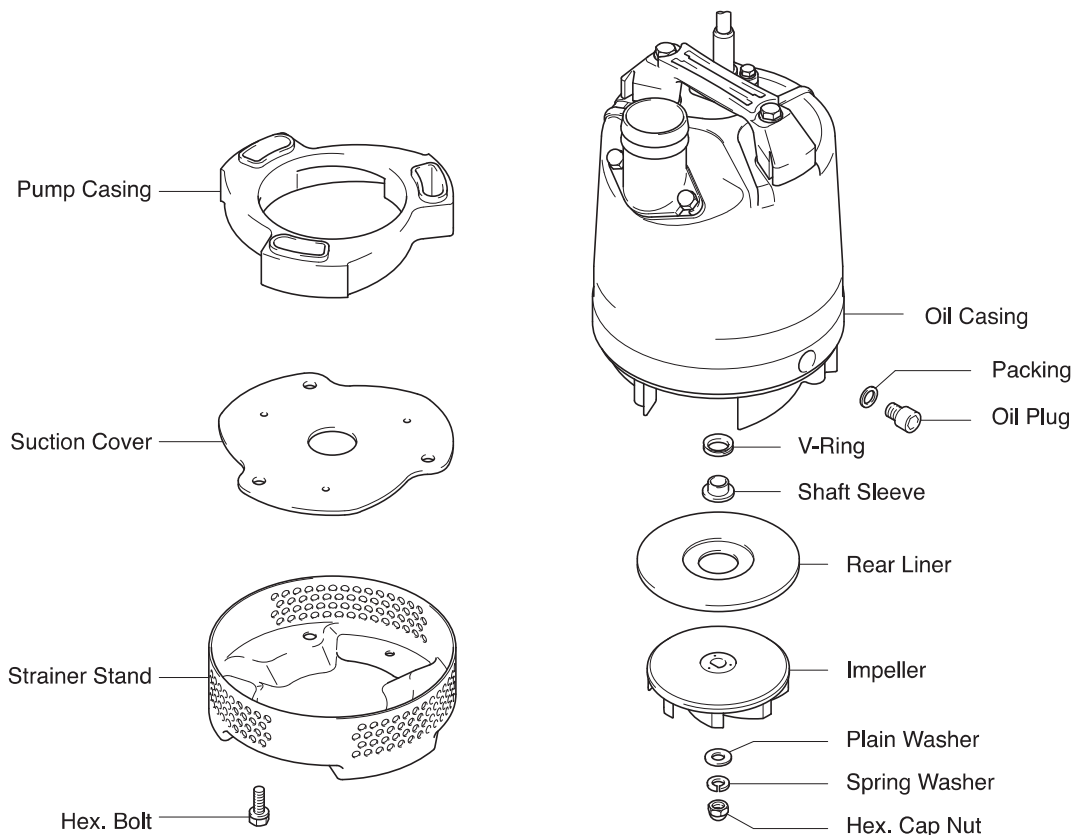

## Reassembly Procedure

Observe the precautions given below and reassemble the unit in the reverse order of disassembly.

**Note:** *After completing the reassembly, make sure to fill the pump with the specified amount of oil. The packings must be replaced with a new part. If any part is worn or damaged, make sure to replace it with a new part.*

After reinstalling the impeller or the suction cover, check that the impeller rotates smoothly and that there is no interference between the pump casing and the suction cover.

### Reassembling models

- (1) Assemble the rubber parts (rear face liner, impeller, and pump casing) after removing debris from them such as sand.
- (2) Mount the v-ring onto the outside of the shaft sleeve as shown in the drawing. When doing so, do not apply oil or other lubrication to the surface where the v-ring contacts the shaft sleeve.
- (3) When attaching the rear liner, make sure the front and back are oriented correctly, and press the liner firmly onto the surface.
- (4) After reinstalling the impeller or the suction cover, check that the impeller rotates smoothly and that there is no interference between it and the suction cover.

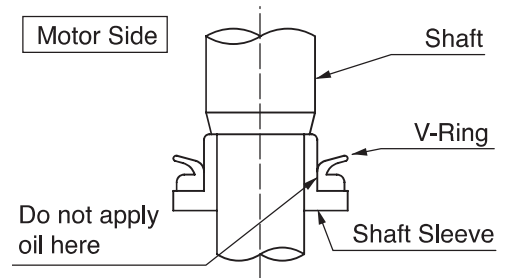

# 9 TROUBLESHOOTING

**⚠ WARNING** To prevent serious accidents, disconnect the power supply before inspecting the pump.

Read this Operation Manual carefully before requesting repair. After re-inspecting the pump, if it does not operate normally, contact the dealer where this equipment was purchased, or the Tsurumi sales office in your area.

Problem	Possible cause	Countermeasure
Pump fails to start; or, starts but stops immediately.	<ul style="list-style-type: none"> <li>① No proper power is supplied (i.e. power outage).</li> <li>② Plug is not inserted.</li> <li>③ Open circuit in cabtyre cable or poor connection.</li> <li>④ Malfunction in float.</li> <li>⑤ Electrode is insulated by debris.</li> <li>⑥ Malfunction in level relay unit.</li> </ul>	<ul style="list-style-type: none"> <li>① Contact the electric power company or an electrical repair shop.</li> <li>② Connect the plug.</li> <li>③ Check whether there is an open circuit in the cabtyre cable or wiring.</li> <li>④ Remove obstacles and check the operation of the float.</li> <li>⑤ Use sandpaper to remove the debris.</li> <li>⑥ Repair or replace the level relay unit.</li> </ul>
Pump starts but stops immediately, causing the motor protector to trip.	<ul style="list-style-type: none"> <li>① Foreign matter is wedged in the impeller, causing the motor protector to trip.</li> <li>② The movement of the stop float is obstructed, causing the start float alone to perform the start and stop operations.</li> <li>③ The voltage is too low.</li> <li>④ A 50Hz unit is used at 60Hz.</li> <li>⑤ The pump has been operated for a long time with its strainer stand clogged.</li> <li>⑥ Malfunction of motor (seizure or water leakage).</li> <li>⑦ The pump is drawing in too much mud.</li> </ul>	<ul style="list-style-type: none"> <li>① Inspect the pump and remove the debris.</li> <li>② Remove obstacles and check the operation of the stop float.</li> <li>③ Provide the rated voltage or use an extension cable that meets the specifications.</li> <li>④ Check the nameplate and replace the pump or the impeller.</li> <li>⑤ Remove the debris from the strainer stand.</li> <li>⑥ Repair or replace.</li> <li>⑦ Place a concrete block under the pump to prevent the pump from drawing in excess mud.</li> </ul>
The pumping volume is low.	<ul style="list-style-type: none"> <li>① The impeller is worn.</li> <li>② The hose is clogged or kinked at its midspan.</li> <li>③ The strainer stand is clogged or is buried.</li> <li>④ The motor rotates in reverse.</li> <li>⑤ A 60Hz pump is used at 50Hz.</li> </ul>	<ul style="list-style-type: none"> <li>① Replace the impeller.</li> <li>② Minimize the bends of the hose, and if the pump is used in a dusty area, place it inside a mesh basket during operation.</li> <li>③ Remove the debris from the strainer stand. Place a concrete block under the pump to prevent the pump from drawing in excess mud.</li> <li>④ Change the power connection.</li> <li>⑤ Check the nameplate and replace the pump or the impeller.</li> </ul>
Pump generates vibration or noise.	<ul style="list-style-type: none"> <li>① Motor bearings are damaged.</li> </ul>	<ul style="list-style-type: none"> <li>① Replace the bearings.</li> </ul>
The pump does not stop automatically.	<ul style="list-style-type: none"> <li>① The movement of the floats is obstructed. The switch in a float is faulty.</li> <li>② The water level of the (stop) float is set lower than the pump's minimum possible operating water level.</li> <li>③ Malfunction in level relay unit</li> <li>④ Electrode is shorted by debris.</li> <li>⑤ Influence by electrical device in the vicinity of the pump.</li> </ul>	<ul style="list-style-type: none"> <li>① Remove the blockage. Or, replace the part.</li> <li>② Set the water level of the (stop) float higher than the pump's minimum possible operating water level.</li> <li>③ Repair or replace the level relay unit.</li> <li>④ Use sandpaper to remove the debris.</li> <li>⑤ Check whether there are any wires that are tangled around the electrode. Check whether there are any electrical devices that could generate electro-magnetic interference, and relocate the unit as necessary.</li> </ul>

The following information is required when ordering repairs or making other inquiries.

Product model	
Manufacturing number	
Purchase date	
Remarks	

## Disposal of Product

Properly dispose of the product by disassembling it, presorting the contents, and sending them to the waste material treatment site.